

**SECOND STAGE SWIVEL**

**WARNING: Service of this SECOND STAGE SWIVEL 'requires' the use of Loctite 243 threadlocker and explicit adherence to the procedures contained herein. Any attempt to service the SECOND STAGE SWIVEL without following these procedures may render the product unsafe, and could result in serious injury or death of the user.**

**TROUBLE SHOOTING**

SYMPTOM	POSSIBLE CAUSE	TREATMENT
* <b>SECOND STAGE SWIVEL does not rotate smoothly, or does not rotate at all.</b>	1. SWIVEL BOLT (6) and/or SWIVEL SETSCREW (12) tightened excessively into the BALL SWIVEL BASE (11).	1. Adjust and tighten to the correct torque(s).
* <b>SECOND STAGE SWIVEL spins freely (not light and smooth).</b>	1. SWIVEL BOLT (6) and/or SWIVEL SETSCREW (12) not sufficiently tightened into the BALL SWIVEL BASE (11).	1. Adjust and tighten to the correct torque(s).
* <b>Leakage present at the LP Hose fitting.</b>	1. Excessive intermediate pressure. 2. Damaged or worn LP Hose end fitting O-ring.	1. Refer to First Stage Troubleshooting Chart. 2. Replace with new.
* <b>Leakage present at the Second Stage Inlet Coupling.</b>	1. Excessive intermediate pressure. 2. Second Stage Inlet Coupling not sufficiently tightened into the Inlet Tube. 3. SECOND STAGE SWIVEL not sufficiently tightened into the Second Stage Inlet Coupling. 4. Damaged or worn NUT RETAINER OUTER O-RING (1) or NUT RETAINER INNER O-RING (3).	1. Refer to First Stage Troubleshooting Chart. 2. Tighten to the correct torque. 3. Tighten to the correct torque. 4. Service the SECOND STAGE SWIVEL, and replace the O-ring(s) with new.
* <b>Leakage present at the SWIVEL BOLT (6).</b>	1. Damaged or worn SWIVEL BASE INNER O-RING (9). 2. SWIVEL BOLT (6) not sufficiently tightened into the BALL SWIVEL BASE (11).	1. Service the SECOND STAGE SWIVEL, and replace the SWIVEL BASE INNER O-RING (9) with new. 2. Tighten to the correct torque.
* <b>Leakage present at the SWIVEL SETSCREW (12).</b>	1. Damaged or worn SWIVEL BASE INNER O-RING (9). 2. SWIVEL BOLT (6) and/or SWIVEL SETSCREW (12) not sufficiently tightened into the BALL SWIVEL BASE (11).	1. Service the SECOND STAGE SWIVEL, and replace the SWIVEL BASE INNER O-RING (9) with new. 2. Adjust and tighten to the correct torque(s).
* <b>Leakage present between the BALL SWIVEL CAP (8) and the BALL SWIVEL BASE (11).</b>	1. Damaged or worn SWIVEL BASE OUTER O-RING (10). 2. SWIVEL BOLT (6) and/or SWIVEL SETSCREW (12) not sufficiently tightened into the BALL SWIVEL BASE (11).	1. Service the SECOND STAGE, and replace the SWIVEL BASE INNER O-RING (9) with new. 2. Adjust and tighten to the correct torque(s).

**NOTE: If leakage is present and any of the O-rings are to be replaced as a "Treatment", Oceanic strongly recommends that the complete SECOND STAGE SWIVEL be inspected and serviced.**

## DISASSEMBLY PROCEDURE

**△ NOTE:** Review the Troubleshooting section to gain a better idea of which internal parts may be worn, and to better advise your customer if service is needed.

1. Remove the Hose from the SECOND STAGE SWIVEL using an 11/16" open end wrench, while holding the hex portion of the BALL SWIVEL BASE (11) secure with an 11/16" thin wall open end wrench.

**△ NOTE:** For units connected to Oceanic servo-assisted Second Stages the Valve Module must be removed from the Housing prior to removing the SECOND STAGE SWIVEL. Refer to Doc. 12-2220 steps 1 to 6 for Zeta Disassembly Procedures and 12-2221 steps 1 to 3 for Omega II Disassembly Procedures.

2. Remove the SECOND STAGE SWIVEL from the Second Stage using an 11/16" open end wrench, while holding the hex portion of the Second Stage Inlet Coupling, or the Inlet Chamber (Omega and Zeta), secure with an open end wrench of the appropriate size.
3. Remove the o-rings from inside the Hose end fitting and the Second Stage Inlet Coupling (or Inlet Chamber), and inspect for any signs of decay, deterioration, or deformity. Discard if found.

**⚠ CAUTION:** The NUT RETAINER (2) and SWIVEL NUT (5) should only be disassembled (steps 4 - 6) if the NUT RETAINER OUTER O-RING (1) or INNER O-RING (3) must be replaced.

4. To remove the SWIVEL NUT (5), secure the hex portion of the BALL SWIVEL BASE (11) in a padded vise oriented with the SWIVEL NUT (5) pointing straight up and remove the NUT RETAINER (2) by turning it out in a counter clockwise direction using a 5/32" allen key (Fig. 1).

5. Remove the NUT RETAINER WASHER (4). Discard and DO NOT attempt to reuse it.

6. Remove the NUT RETAINER OUTER O-RING (1) and INNER O-RING (3). Discard and DO NOT attempt to reuse them.

7. With the SWIVEL still in the vise, separate the BALL SWIVEL CAP (8) and BALL SWIVEL BASE (11) by loosening the SWIVEL BOLT (6) by turning it counter clockwise with a flat blade screwdriver (Fig. 2). DO NOT pull the BOLT out of the CAP at this time.

8. Remove the BALL SWIVEL BASE (11) from the vise and remove the SWIVEL SETSCREW (12) by turning it counter clockwise out of the BALL SWIVEL BASE (11) with a 3/32" allen key.

9. Remove the SWIVEL BASE INNER O-RING (9) from the SWIVEL BOLT (6) (Fig. 3). Discard and DO NOT attempt to reuse it.

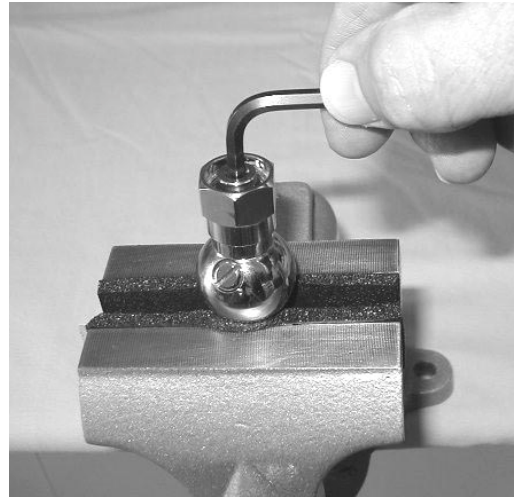

Fig. 1

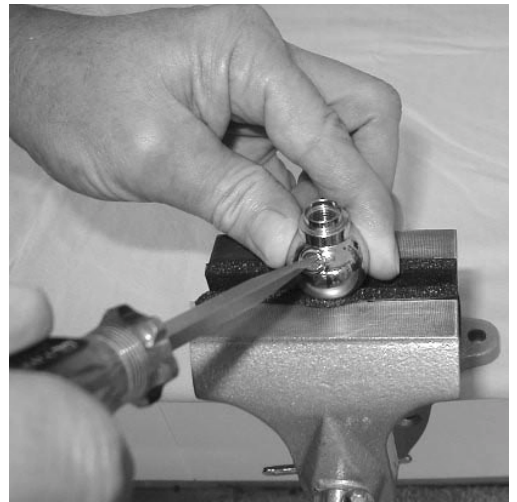

Fig. 2



Fig. 3

## SECOND STAGE SWIVEL

10. Remove the SWIVEL BOLT (6) from the BALL SWIVEL CAP (8).
11. Remove the nylon SWIVEL BOLT Washer (7). Discard and DO NOT attempt to reuse it.
12. Remove the SWIVEL BASE OUTER O-RING (10) from the groove in the BALL SWIVEL BASE (11). Discard and DO NOT attempt to reuse it.
13. Prior to cleaning, use a dental pick to remove any thread locking adhesive found in threads of any of the component parts.

## REASSEMBLY PROCEDURE

**△ NOTE:** Prior to reassembly, it is necessary to inspect all parts, both new and those being reused. Ensure that o-rings are clean and supple, and that every part and component has been thoroughly cleaned and dried.

**⚠ WARNING:** Use only genuine Oceanic parts, subassemblies, and components whenever assembling Oceanic products. DO NOT attempt to substitute an Oceanic part with another manufacturer's, regardless of any similarity in shape, size, or appearance. Doing so may render the product unsafe, and could result in serious injury or death of the user.

**△ NOTE:** If the NUT RETAINER (2) was removed, perform steps 1 - 3, otherwise proceed directly to step 4.

1. Lubricate and install the NUT RETAINER OUTER O-RING (1) and INNER O-RING (3) on the NUT RETAINER (2).
2. Using a syringe, carefully put one drop of Loctite 243 on the threads inside the BALL SWIVEL CAP (8) (Fig. 4).

**⚠ CAUTION:** Place the drop on the threads at a sufficient depth (approximately 3 - 6 threads into the opening) to avoid contact with the NUT RETAINER INNER O-RING (3) when the NUT RETAINER (2) is installed.

3. Place the NUT RETAINER WASHER (4) on the NUT RETAINER (2) positioned at the top of the threads just below the NUT RETAINER INNER O-RING.
4. Insert the NUT RETAINER (2) through the SWIVEL NUT (5) and thread it clockwise into the BALL SWIVEL CAP (8) (Fig. 5). Tighten the NUT RETAINER (2) with a 5/32" allen key to a torque of 20 in-lbs. DO NOT over tighten!
5. Lubricate and install the SWIVEL BASE INNER O-RING (9) and OUTER O-RING (10) into the BALL SWIVEL BASE (11) (Fig. 6).
6. Place the nylon BOLT WASHER (7) on the stem of the SWIVEL BOLT (6).

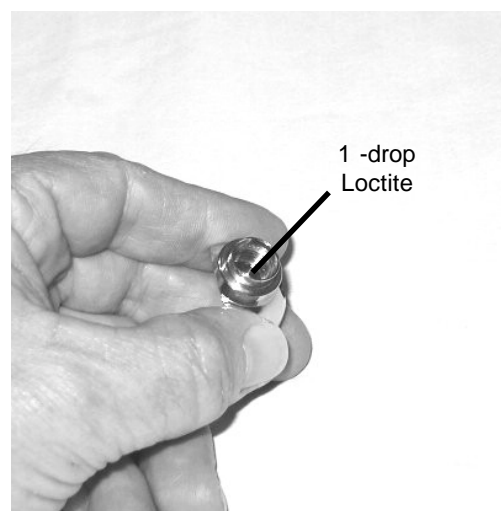

Fig. 4

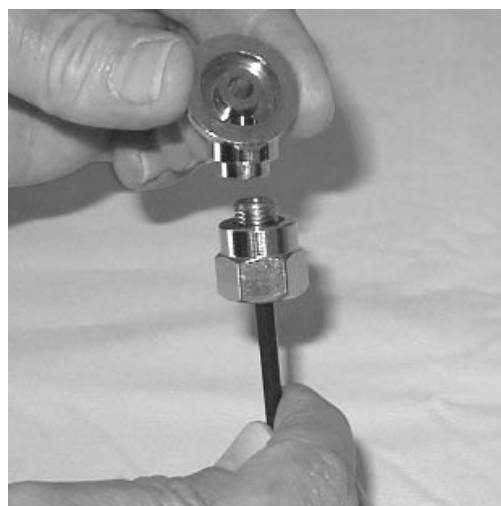

Fig. 5



Fig. 6

## SECOND STAGE SWIVEL

7. Insert the SWIVEL BOLT (5) with WASHER (7) through the BALL SWIVEL CAP (8), and carefully push the threads of the BOLT through the SWIVEL BASE INNER O-RING (9) and into the BALL SWIVEL BASE (11) (Fig. 7).
8. Using a flat blade screwdriver, tighten the SWIVEL BOLT (6) by turning it clockwise until it just stops. Adjust the SWIVEL BOLT (6) so the BALL SWIVEL CAP (8) and BALL SWIVEL BASE (11) come together gently squeezing the SWIVEL BASE OUTER O-RING (10), then loosen the SWIVEL BOLT (6) by turning it counter clockwise 2 - 3 full rotations.
9. Orient the SECOND STAGE SWIVEL so the SETSCREW opening in the BALL SWIVEL BASE is facing up, and using a syringe, carefully apply one drop of Loctite 243 (through the SETCREW opening) into the threads of the SWIVEL BOLT (6) (Fig. 8).
10. Lightly retighten the SWIVEL BOLT (6) (**reference 5 in-lbs**). **DO NOT over tighten!**
11. Insert the SWIVEL SETSCREW (12) into the BALL SWIVEL BASE (11) and tighten by turning it clockwise with a 3/32" allen key **to a torque of 10 in-lbs. DO NOT over tighten!**

**⚠ CAUTION: If swiveling action is not light and smooth, loosen the SWIVEL SETSCREW (12) and repeat steps 8 - 11.**

12. Wipe any excess Loctite from the SECOND STAGE SWIVEL, and allow the Loctite to harden for 24 hours before testing.
13. Lubricate and install the o-rings in the Hose end fitting and Second Stage Inlet Coupling (or Inlet Chamber).
14. Thread the SECOND STAGE SWIVEL clockwise into the LP Hose end fitting by hand until secure, then tighten **to a torque of 55 in-lbs** with an 11/16" thin wall crows foot wrench, while holding the hex portion of the LP Hose end fitting secure with an 11/16" open end wrench.
15. Thread the SECOND STAGE SWIVEL clockwise onto the Second Stage Inlet Coupling (or Inlet Chamber) by hand until secure (Fig. 10), then tighten **to a torque of 55 in-lbs** with an 11/16" crows foot wrench, while holding the hex portion of the Second Stage Inlet Coupling (or Inlet Coupling) secure with open end wrench of the appropriate size.

**⚠ NOTE: Oceanic servo-assisted Second Stages should be Leak Tested before the Valve Module is reinstalled into the Housing. Refer to Doc. 12-2220 for Zeta Reassembly Procedures and Doc. 12-2221 for Omega II Reassembly Procedures.**



Fig. 7

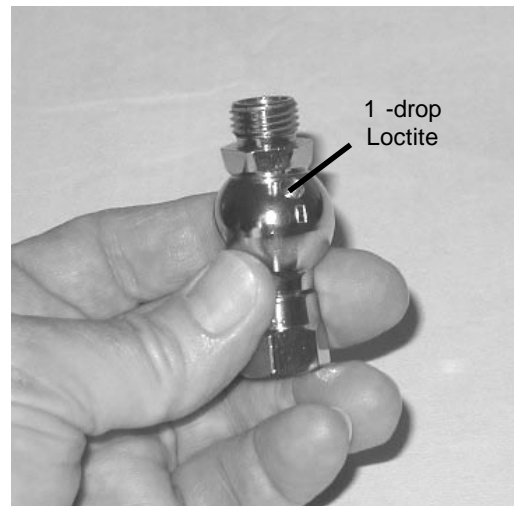

Fig. 8



Fig. 9

**SECOND STAGE SWIVEL**

**FINAL TESTING**

1. Connect the regulator assembly to a pure breathing gas source of 3,000 PSI (208 BAR), slowly pressurize, and perform the Leak detection Test specified in the Initial Inspection Procedure.

**△ NOTE:** During the Leak Test, the **SECOND STAGE SWIVEL** must operate freely. Refer to the Trouble Shooting section to determine the possible cause and treatment of any leakage that may be present.

**⚠ CAUTION:** The **NUT RETAINER (2)** and **SWIVEL NUT (5)** should only be disassembled if the **NUT RETAINER OUTER O-RING (1)** or **INNER O-RING (3)** must be replaced.

Dia. No.	Part #	Description
<b>1b</b>	<b>2.010</b>	<b>O-RING, NUT RETAINER OUTER</b>
2c	36631	RETAINER, NUT
<b>3b</b>	<b>2.010</b>	<b>O-RING, NUT RETAINER INNER</b>
<b>4b</b>	<b>310211</b>	<b>WASHER, SWIVEL NUT</b>
5c	310202	NUT, SWIVEL
6c	36632	BOLT, SWIVEL
<b>7b</b>	<b>36635</b>	<b>WASHER, SWIVEL BOLT</b>
8c	36633	CAP, BALL SWIVEL
<b>9b</b>	<b>2.008</b>	<b>O-RING, SWIVEL BASE INNER</b>
<b>10b</b>	<b>2.018</b>	<b>O-RING, SWIVEL BASE OUTER</b>
11c	36634	BASE, BALL SWIVEL
12c	36637	SETSCREW, SWIVEL
n/s	call	KIT, SERVICE (includes all <b>Bold</b> items)

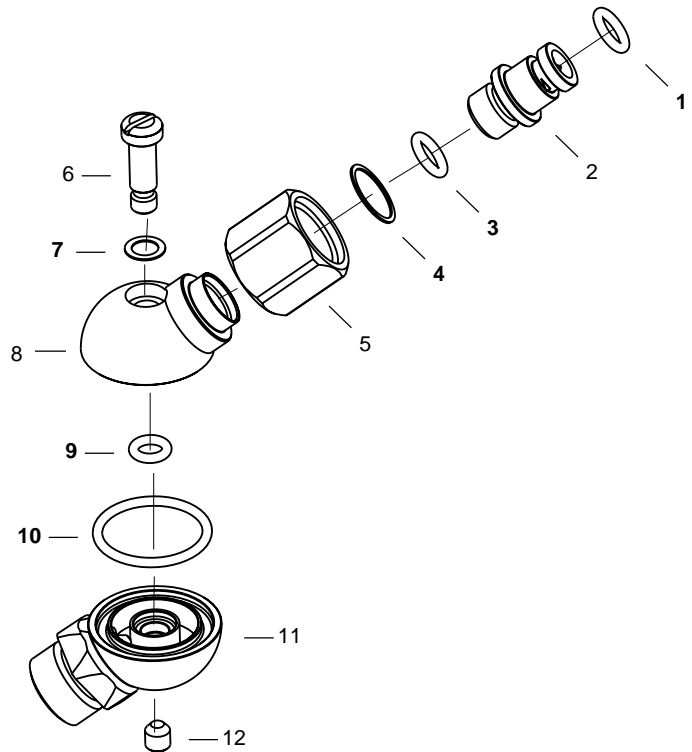

**SPECIFICATIONS**

**Torques**

P/N 6631	NUT RETAINER	20 in-lbs
P/N 6632	SWIVEL BOLT	5 in-lbs
P/N 6337	SWIVEL SETSCREW	10 in-lbs
	Swivel Assembly to LP Hose	50 to 60 in-lbs
	Swivel Assembly to Inlet Coupling	50 to 60 in-lbs

**Specialty Tools**

P/N 40.2302	Christo-Lube MCG111 - 2 oz
P/N 40.9520	O-ring Tool Kit

**Standard Tools**

P/N N/A	Inch Pounds Torque Wrench
P/N N/A	3/32" Hex Key Socket
P/N N/A	11/16" Crows Foot Wrench
P/N N/A	11/16" Open End Wrench
P/N N/A	3/4" Open End Wrench
P/N N/A	Standard Screwdriver - Medium
P/N N/A	1/4" Nut Driver
P/N N/A	3/32" Allen Key
P/N N/A	5/32" Allen Key
P/N N/A	Syringe
P/N N/A	Loctite 243 Threadlocker

Doc. 12-2219-r01 (12/31/00)